

SERIE 294 TIPO 21-30-1000

294 S TIPO 21-32-900

MONTAGGIO IDRAULICO SUPERAUTOMATICO
SELF-ERECTING HYDRAULIC TOWER CRANE
GRUE A TOUR HYDRAULIQUE A MONTAGE RAPIDE
HYDRAULISCHER TURMDREHKRAN MIT SCHNELLMONTAGE
GRUA AUTOMONTANTE HIDRAULICA DE MONTAJE RAPIDO

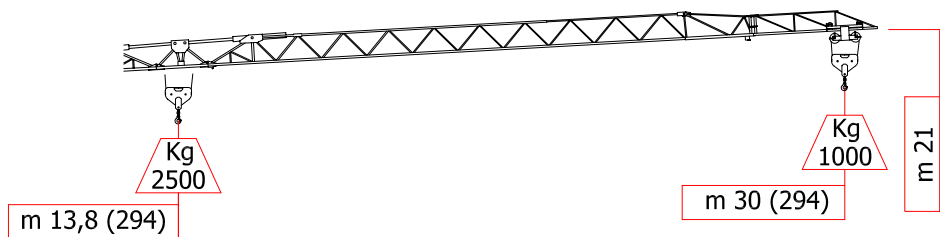
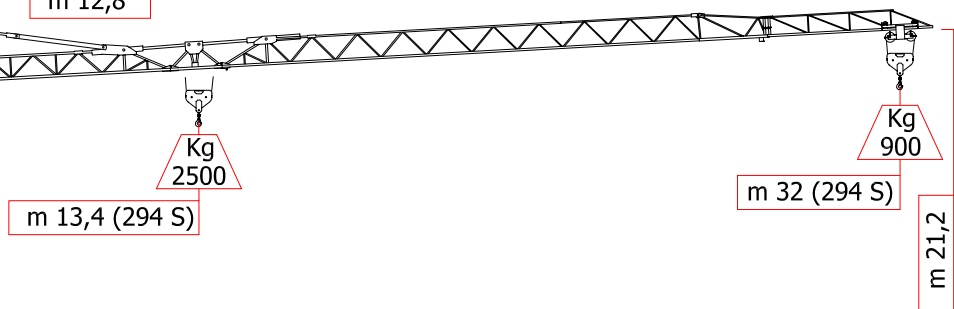
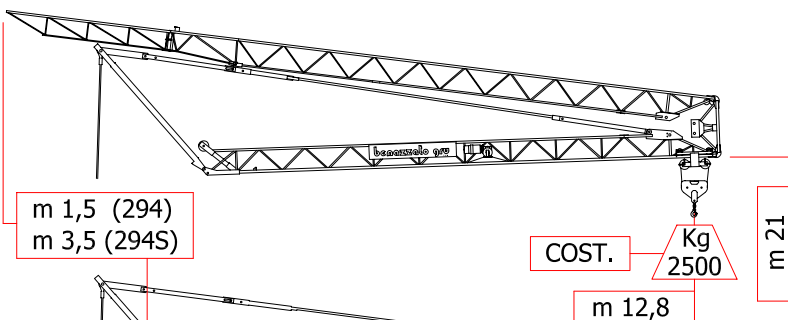
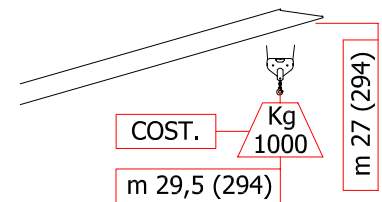
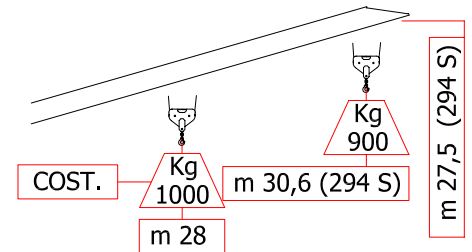

R = 2,2m
 Z = 19,2 t

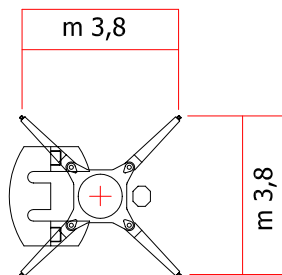

21 t

	Kg	SERIE 294		2500	2260	2090	1820	1610	1440	1290	1180	1080	1000	
	m		13,4	13,8	15	16	18	20	22	24	26	28	30	32
	Kg	SERIE 294 S	2500	2420	2190	2030	1760	1560	1390	1250	1140	1040	980	900

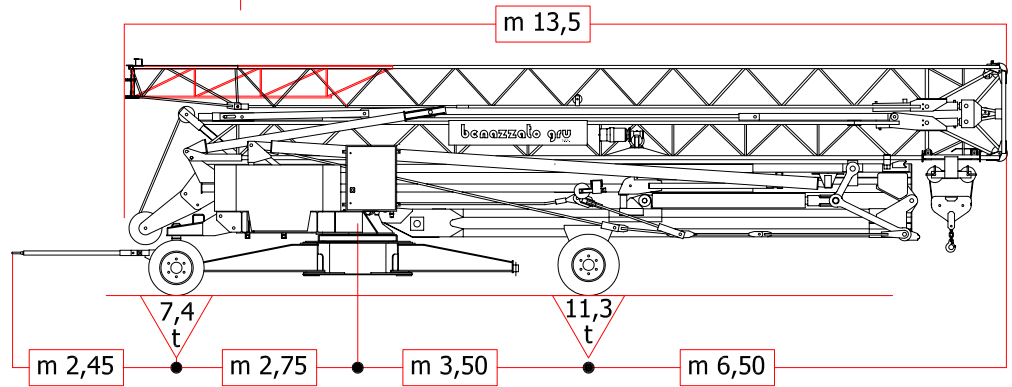
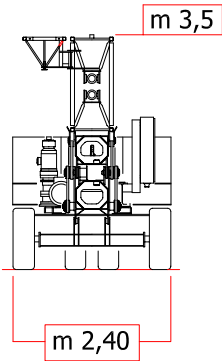
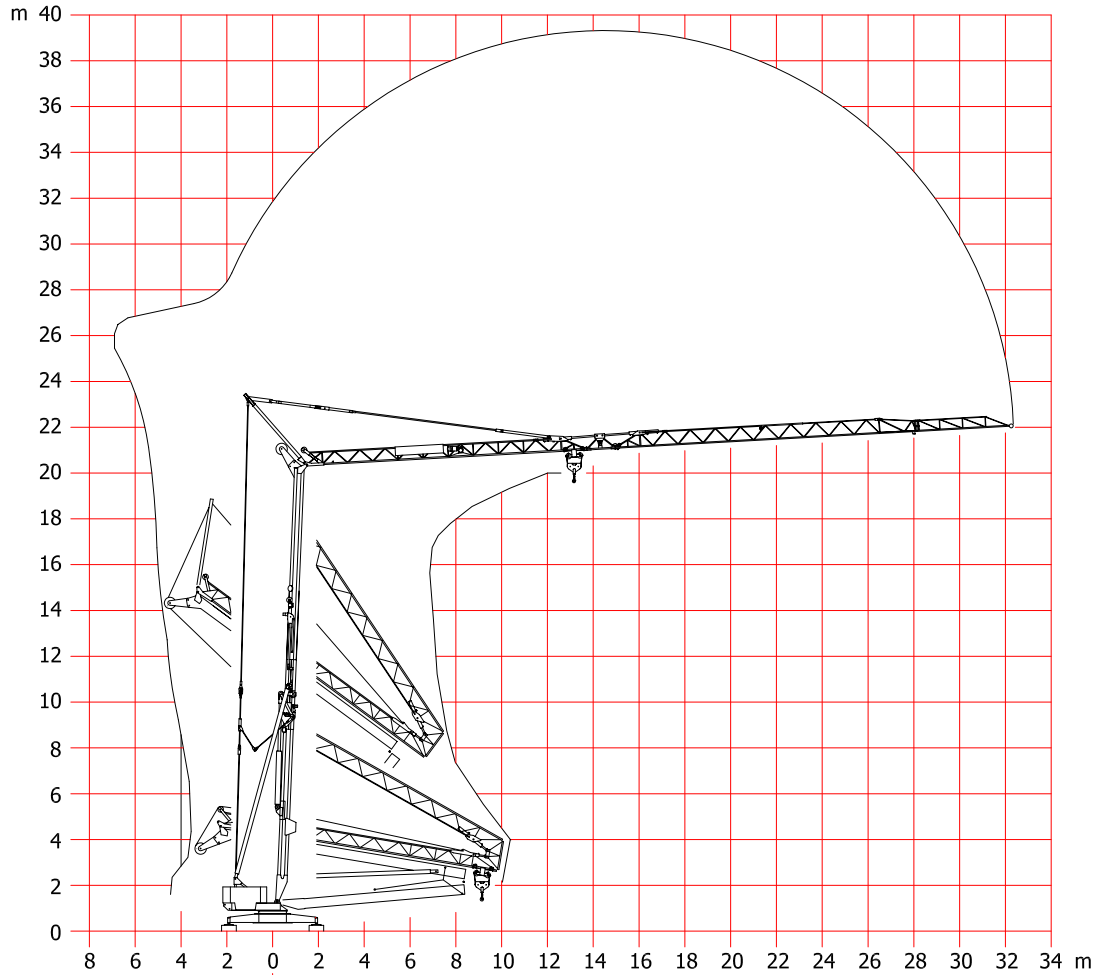
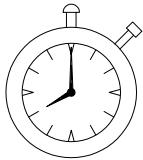
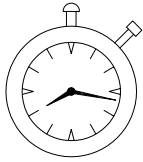

DIN 15018 H₁ B₂ B₃ DIN 15019

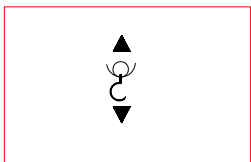

m/min	48-1250 Kg
m/min	24-2500 Kg
m/min	5-2500 Kg

KW	10,3
KW	10,3
KW	2,6

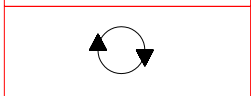

rpm	0 - 1
upm	

KW	2,2
----	-----



m/min	40 - 1250 Kg
m/min	20 - 2500 Kg

KW	2,2
KW	2,2

TRIFASE
TRIFASICA
TRIPHASEE
THREE-PHASE
DREHSTROM

V 400

Hz 50

MAX. POWER
KVA 19

Torre in tubo ottagonale
Crane with octagonal closed beam tower
Grue avec mat en tube octogonal
Kran mit oktagonalem Rohrturm
Torre de tubo octogonal

Riserva di modiffiche - Subject to modifications - Modifications reservées - Aenderungen vorbehalten - Reserva de modificaciones