

CM 74S4

Gru idraulica a montaggio rapido

Hydraulic crane with quick assembling

Grue hydraulique à montage rapide

Hydraulischer Schnellmontagekran

Grúa hidráulica de montaje rápido









EN 14439 C25

DIN 15018-H1/B3

PROGETTO e COSTRUZIONE / DESIGN and CONSTRUCTION:
LUIGI CATTANEO S.p.A

Prestazioni - Performances - Prestations - Leistungen - Prestaciones

	 kVA	 400V - 50Hz 12 kVA					
	kW/g/min		1°	2°	3°	4°	
			m/min	5	18	30	40
	inverter	3/1400	kg	2.500	2.500	1500	1000
			m/min	25 - 50			
	inverter	2,2/1400	g/min	0,4 - 0,9			

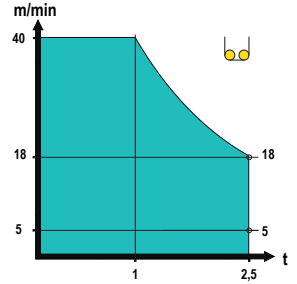

Montaggio - Erection - Montage - Montage - Montage

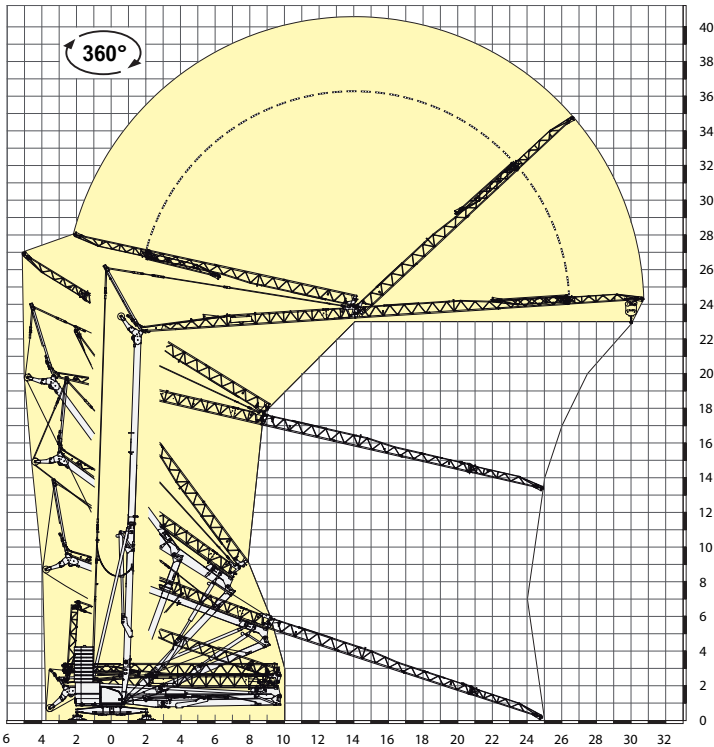

CM 74S4

Contrappeso in lastre di cemento armato - Ferro-concrete ballast slabs
 Contrepoids en plaques de béton armé - Gegengewicht aus Betonplatten - Lastre en hormigón armado

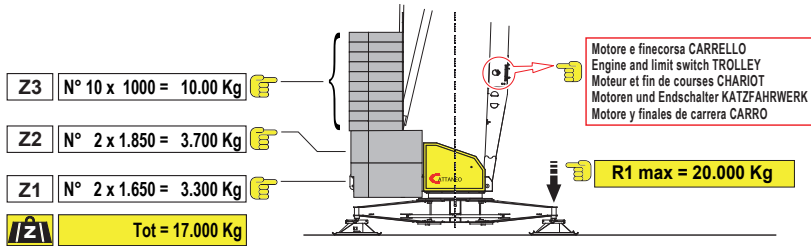

Trasporto - Transport - Transport - Transport - Transporte

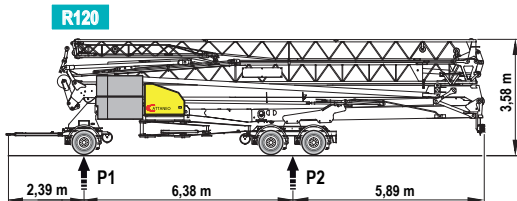
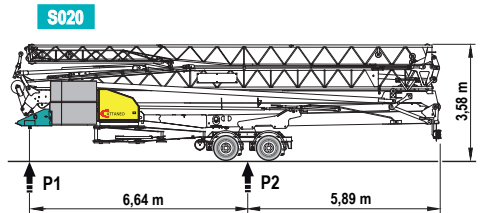
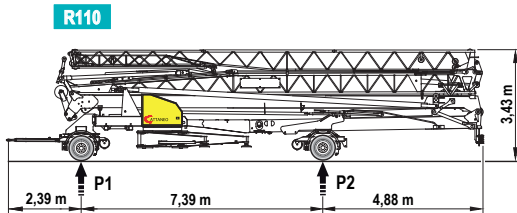
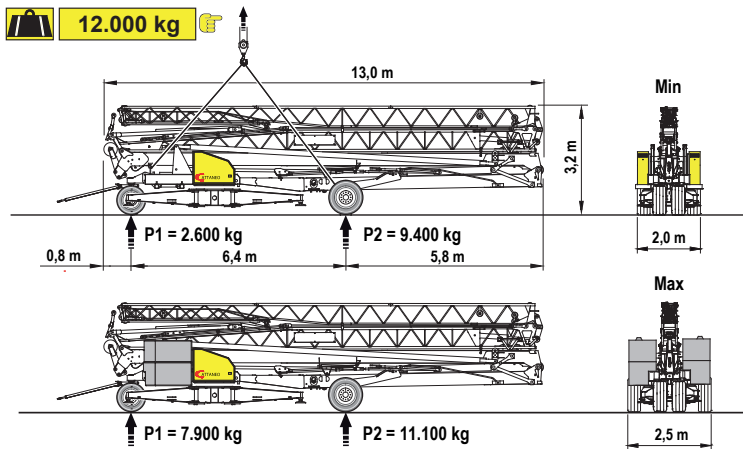

Otto	km/h	P1	P2	
R110	80	4.750	8.770	kg
R120	80	9.280	12.230	kg
S020	80	8.280	12.230	kg

Dir. 2007/46/CE