

GRU A MONTAGGIO RAPIDO  
 GRUE A MONTAGE RAPIDE  
 GRUA DE RAPIDO MONTAJE  
 GRUA DE MONTAGEM RAPIDA  
 QUICK SELFERECTING CRANE  
 HYDRAULISCHER SCHNELLMONTAGEKRAN

Curve di carico – Courbes de charges – Load diagrams – LastKurven – Curvas de cargas

	<table border="1"> <tr> <td>3</td> <td>23</td> <td>27</td> <td>m</td> </tr> <tr> <td>700</td> <td>700</td> <td>700</td> <td>kg</td> </tr> </table>	3	23	27	m	700	700	700	kg								
3	23	27	m														
700	700	700	kg														
	<table border="1"> <tr> <td>3</td> <td>11,7</td> <td>12</td> <td>16</td> <td>20</td> <td>24</td> <td>27,7</td> <td>m</td> </tr> <tr> <td>2400</td> <td>2400</td> <td>2310</td> <td>1610</td> <td>1220</td> <td>970</td> <td>800</td> <td>kg</td> </tr> </table>	3	11,7	12	16	20	24	27,7	m	2400	2400	2310	1610	1220	970	800	kg
3	11,7	12	16	20	24	27,7	m										
2400	2400	2310	1610	1220	970	800	kg										
	<table border="1"> <tr> <td>3</td> <td>12,7</td> <td>16</td> <td>20</td> <td>23,7</td> <td></td> <td></td> <td>m</td> </tr> <tr> <td>2400</td> <td>2400</td> <td>1810</td> <td>1375</td> <td>1100</td> <td></td> <td></td> <td>kg</td> </tr> </table>	3	12,7	16	20	23,7			m	2400	2400	1810	1375	1100			kg
3	12,7	16	20	23,7			m										
2400	2400	1810	1375	1100			kg										
	<table border="1"> <tr> <td>3</td> <td>13,3</td> <td>m</td> </tr> <tr> <td>2400</td> <td>2400</td> <td>kg</td> </tr> </table>	3	13,3	m	2400	2400	kg										
3	13,3	m															
2400	2400	kg															

Reazioni – Reactions – Réactions – Eckdrücke – Reacciones

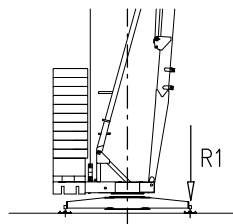

R1 ● 16 t ■ 12 t

▲ 9,4 t ○ 18,1 t

- |                               |                                       |                                      |
|-------------------------------|---------------------------------------|--------------------------------------|
| ● Reazioni in servizio        | ● Reactions in service                | ● Réactions en service               |
| ■ Reazioni fuori servizio     | ■ Reactions out of service            | ■ Réactions hors service             |
| ▲ Peso della gru senza assali | ▲ Dead weight without transport axles | ▲ Poids de construction sans essieux |
| ○ Peso zavorra rotante        | ○ Ballast weight                      | ○ Poids du lest                      |
- 
- |  |  |   |
|--|--|---|
| ● Reaktionskräfte in betrieb               | ● Reacciones en servicio                 | ● Em serviço                              |
| ■ Reaktionskräfte außer betrieb            | ■ Reacciones fuera de servicio           | ■ Fora de serviço                         |
| ▲ Konstruktionsgewicht ohne transportachse | ▲ Peso de la grua sin tren de transporte | ▲ Peso de la grua sem carro de transporte |
| ○ Ballastgewicht                           | ○ Peso de lastre                         | ○ Peso de lastre rotativo                 |

Montaggio – Montage – Erection – Montage – Montaje

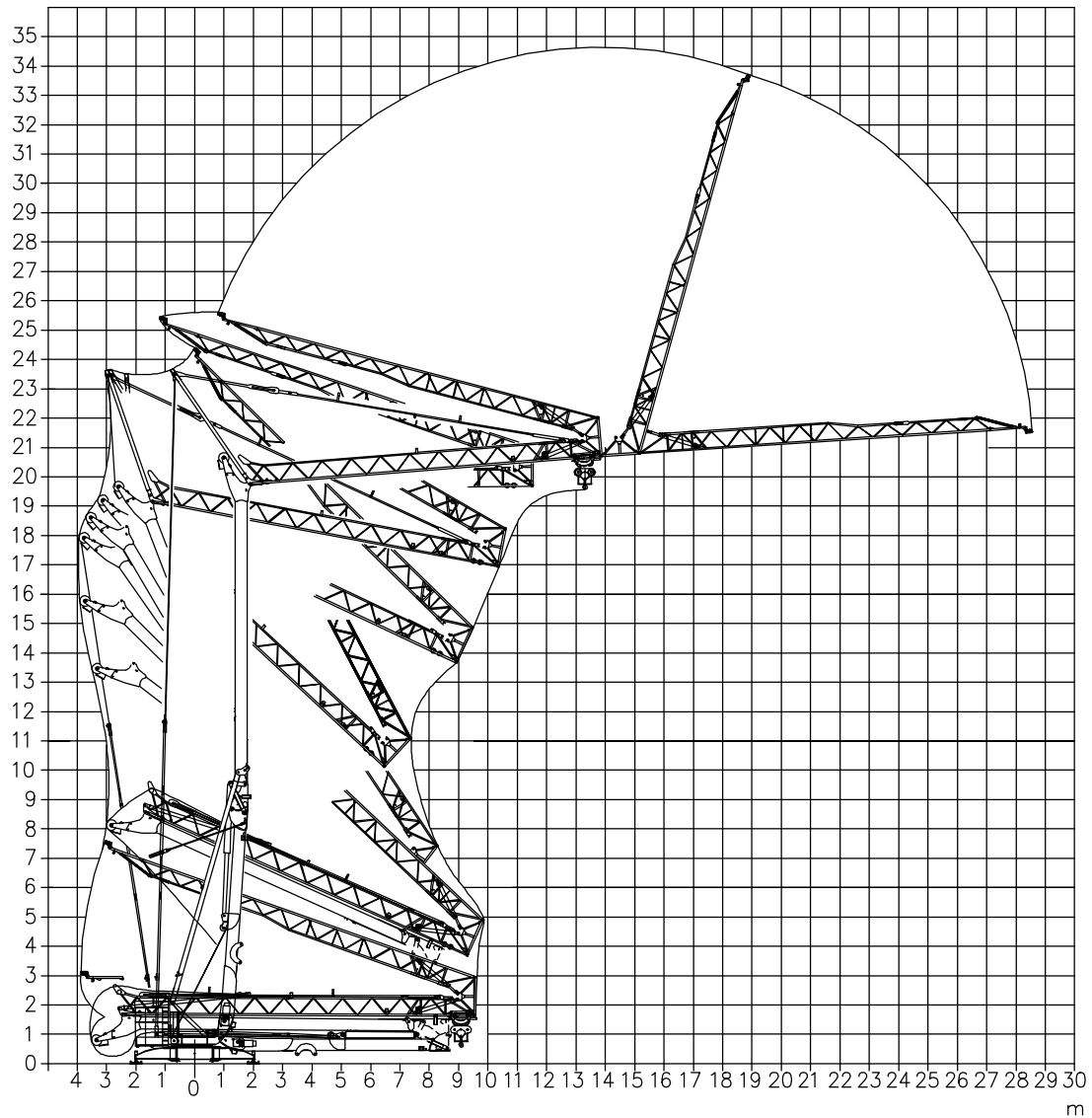



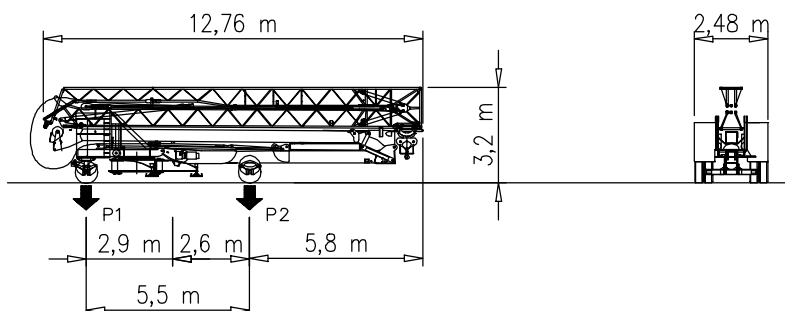

Trasporto – Transport – Transport – Transport – Transporte

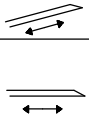

P1	Kg	7650
P2	Kg	8130
Ptot	Kg	15780

Meccanismi – Mechanisms – Mécanismes – Antriebe – Mecanismos

Sollevamento Hoisting Elevaciòn			1a	4 m/min	2400 kg	6,6 kW (Hp 9)
			2a	16 m/min	2400 kg	
			3a	32 m/min	1200 kg	
Carrello Trolleying Distribuciòn			2a	30 m/min	2.2 kW (Hp 3)	
			1a	15 m/min		
			2a	30 m/min		
Rotazione Slewing Orientaciòn			1a	0 → 0.8	giri/min tr/min rp/min	2.2 kW (Hp 3)
			2a			
			3a			

Rete elettrica – Réseau – Mains supply – Netzstrom – Red	400V – 50 Hz
--	--------------

Potenza elettrica necessaria – Puissance électrique nécessaire Necessary electric power – Anschlusswert – Potencia eléctrica necesaria	17,5 kVA
---	----------

**AFM Gru** FMgru s.r.l.  
via Emilia 11-29010 Pontenure PC ITALY  
tel. 0523/510446 ric.aut. fax 0523/510365  
www.fmgru.com e-mail: info@fmgru.com

FEM 1.001-A3  
2000/14/CE



Documento commerciale non contrattuale  
Per tutte le informazioni tecniche riferirsi  
alle corrispondenti istruzioni

Unverbindliches Vertriebsdokument.  
Für technische Informationen, siehe die  
entsprechenden Anweisungen.

This commercial document is not legally  
binding. For any technical information, please  
refer to the corresponding instructions.

Documento comercial no contractual  
Para cualquier información técnica,  
ver la noticia correspondiente.

Code: 15ICA37B45A0			
Ed.	Data	Rev	Data
1	18.09.06	0	18.09.06