

Turmdrehkran

Tower Crane / Grue à tour / Gru a torre
Grúa torre / Guindaste de torre

32 TTR

30 - 57 mt

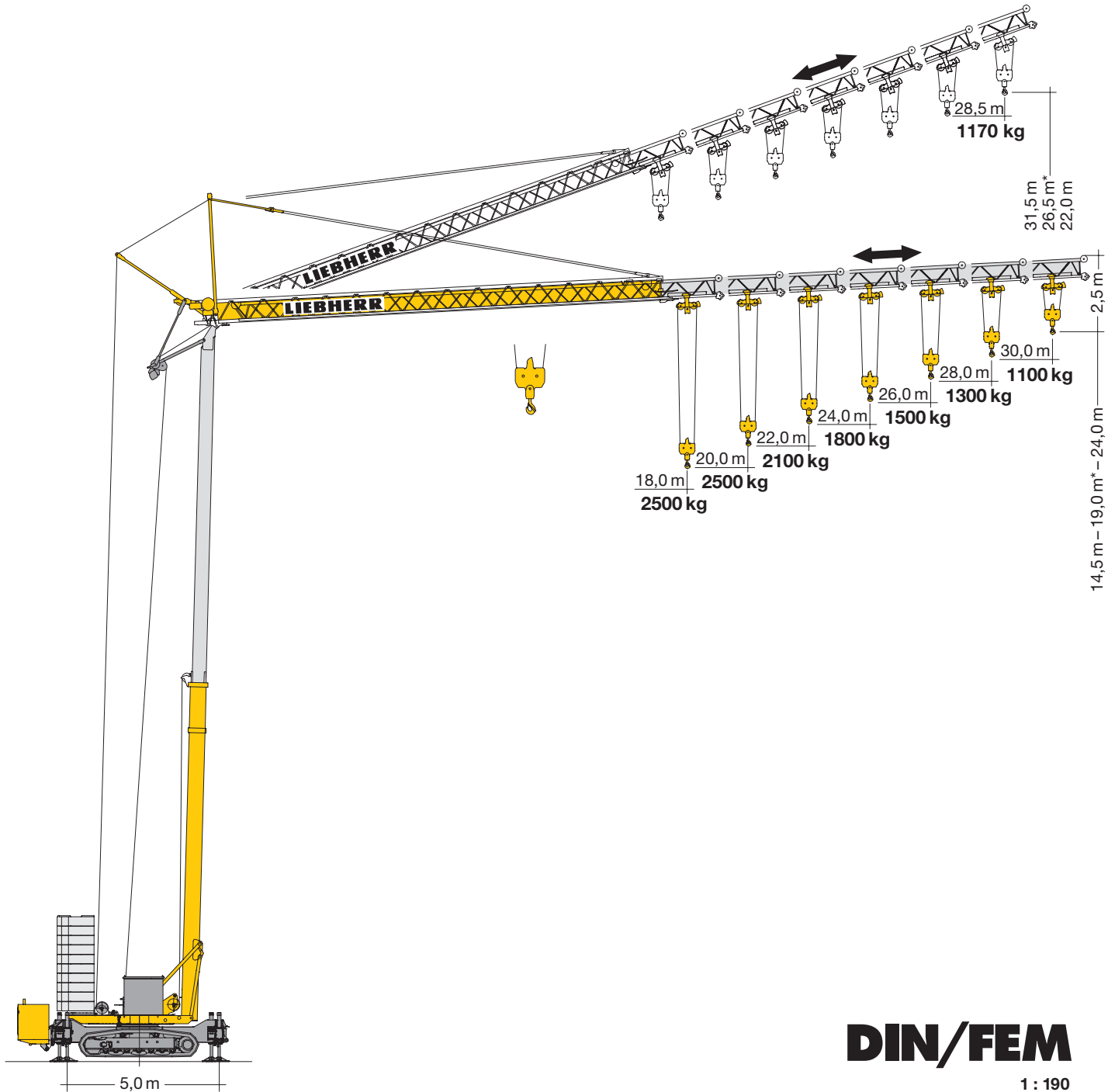



DIN/FEM

1 : 190

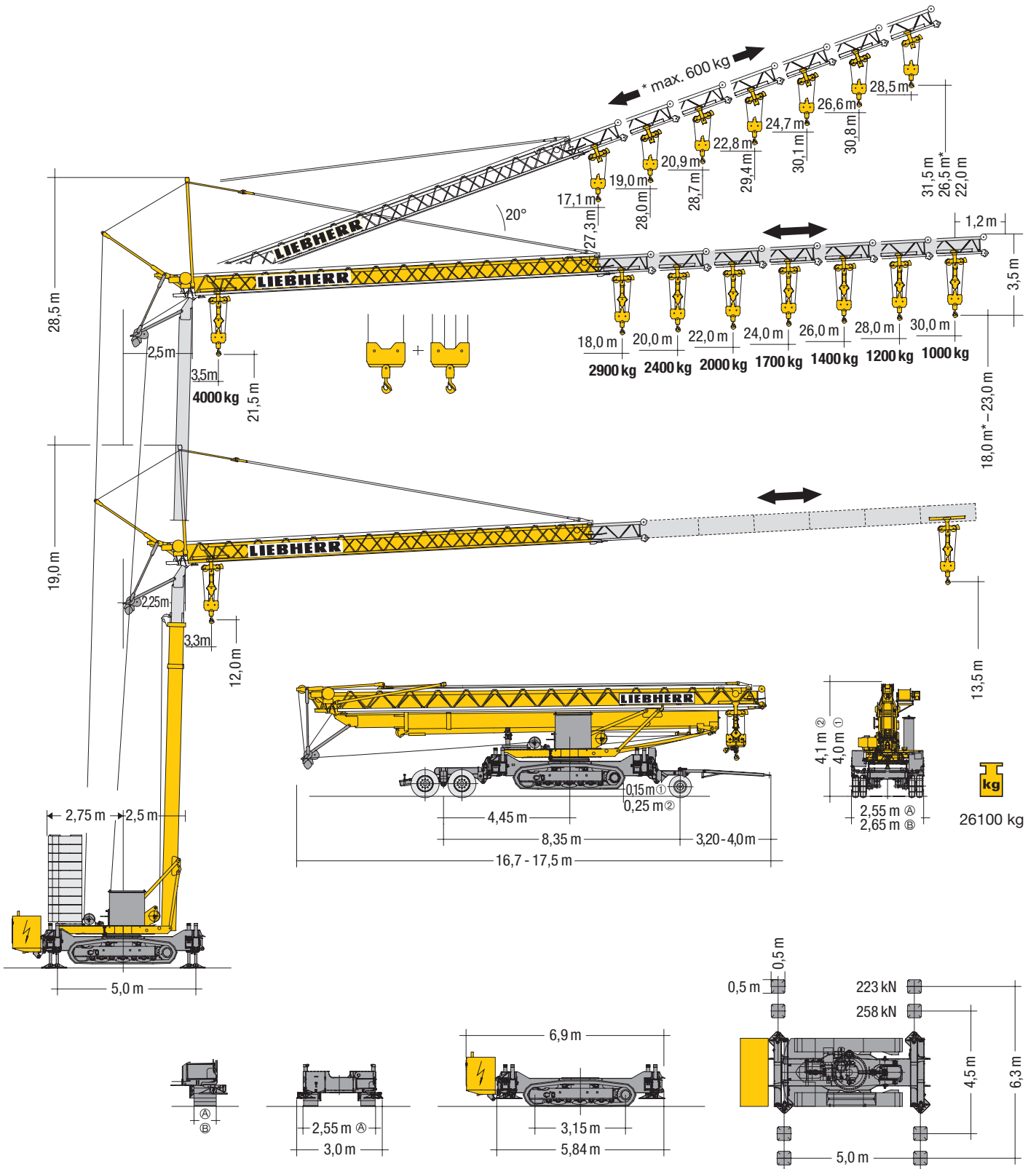
LIEBHERR

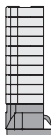

Gewicht Weight / Poids / Peso / Peso / Pesos

	17500 kg		ca. 23000 kg
--	----------	---	--------------

* siehe Betriebsanweisung. / see instruction manual.
voir manuel de service. / vedi manuale d'istruzione.
ver manual de instrucción. / ver manual de instruções.



























































Kettenbreite / Chain width / Largeur de chaîne
Larghezza cingoli / Anchura de cadena
Comprimento dos rastros ⓐ = 0,5 m / ⓑ = 0,6 m

ⓐ 0,15 m \triangleq 4,0 m
ⓑ 0,25 m \triangleq 4,1 m

Ausladung und Tragfähigkeit

Radius and capacity / Portée et charge / Sbraccio e portata / Alcances y cargas / Alcance e capacidade de carga

m	m/kg	5,0 m x 4,5 m / 5,0 m x 6,3 m														
		16,0	17,0	18,0	19,0	20,0	21,0	22,0	23,0	24,0	25,0	26,0	27,0	28,0	29,0	30,0
30,0	3,3 - 16,3 2500	2360	2180	2030	1900	1780	1670	1570	1490	1410	1340	1270	1210	1150	1100	
28,0	3,3 - 17,1 2500	2500	2340	2180	2030	1900	1790	1690	1600	1510	1440	1370	1300			
26,0	3,3 - 17,7 2500	2500	2440	2270	2120	1990	1870	1760	1670	1580	1500					
24,0	3,3 - 18,7 2500	2500	2500	2440	2280	2140	2020	1900	1800							
22,0	3,3 - 19,2 2500	2500	2500	2500	2380	2230	2100									
20,0	3,3 - 20,0 2500	2500	2500	2500	2500											
18,0	3,3 - 18,0 2500	2500	2500													

m	m/kg	5,0 m x 4,5 m / 5,0 m x 6,3 m														
		16,0	17,0	18,0	19,0	20,0	21,0	22,0	23,0	24,0	25,0	26,0	27,0	28,0	29,0	30,0
30,0	3,3 - 11,2 4000	2240	2070	1920	1780	1670	1560	1470	1380	1300	1230	1170	1110	1050	1000	
28,0	3,3 - 11,8 4000	2400	2220	2060	1920	1800	1680	1580	1490	1410	1330	1260	1200			
26,0	3,3 - 12,1 4000	2510	2320	2160	2010	1880	1760	1660	1570	1480	1400					
24,0	3,3 - 12,8 4000	2710	2510	2330	2180	2040	1910	1800	1700							
22,0	3,3 - 13,2 4000	2830	2620	2440	2270	2130	2000									
20,0	3,3 - 13,7 4000	2980	2760	2570	2400											
18,0	3,3 - 14,2 4000	3130	2900													

Auslegersteilstellung 20°
 Elevated jib 20°
 Flèche inclinée 20°
 Braccio inclinato a 20°
 Pluma inclinada 20°
 Lança inclinada 20°

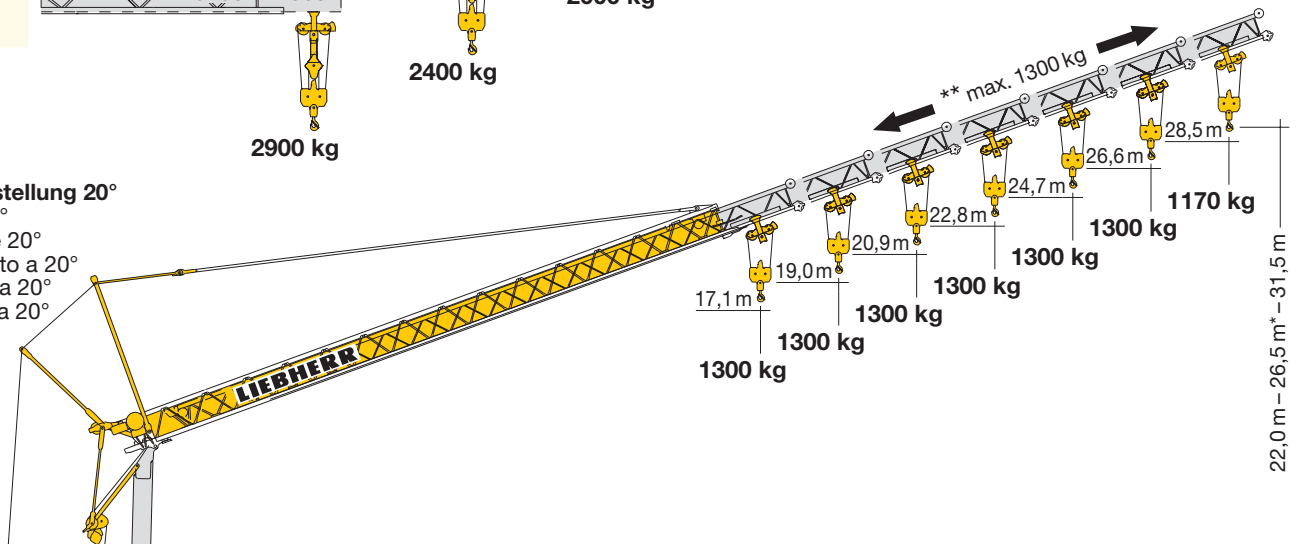

Geländegängigkeit

Off-road capability / Aptitude en tout terrain / Idoneità al fuoristrada / Aptitud de marcha sobre toda clase de terrenos / Capacidade de funcionamento sobre todo o tipo de terrenos

	30 %	15 %	8 %
	15 %	10 %	3 %
	14 N/cm ² [Ⓐ] 12 N/cm ² [Ⓑ]	25 N/cm ² [Ⓐ] 21 N/cm ² [Ⓑ]	25 N/cm ² [Ⓐ] 21 N/cm ² [Ⓑ]
V_{max}	25 m/min	10 m/min	10 m/min

Antriebe

Driving units / Mécanismes d'entraînement / Azionamenti / Mecanismos / Mecanismos

	U/min. 0 ↔ 0,8 sl./min tr./min	2,2 kW EDC
	20,0 / 40,0 m/min	1,8 / 3,5 kW 20° * 2,8 / 3,5 kW 20° **
	10,0 m/min	1,8 kW 2,8 kW 20°
	4,0 m/min	5,0 kW





	Stufe / Step / Cran Marcia / Velocidad Velocidade	kg	m/min
11,0 kW KL 	1	2500	5,0
	2	2500	20,0
	3	1300	40,0
11,0 kW FU 	1	2000 4000	5,0 2,5
	2	2000 4000	20,0 10,0
	3	1300 2600	40,0 20,0
11,0 kW FU 	1	2500	4,0
	2	2500	20,0
	3	1300	38,0
	4	1000	50,0
	1	2000 4000	4,0 2,0
	2	2000 4000	20,0 10,0
	3	1300 2600	38,0 19,0
	4	1000 2000	50,0 25,0

	400 V	Hz	kVA
50,0 m 77,0 m	4 x 6 mm ² KL 4 x 6 mm ² FU	50	22,0 KL 20,0 FU

	Hz	kVA
400 V / 3 ~	50	50

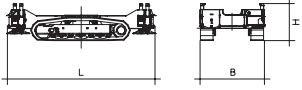
	C.O.08.0031	
BGL		95 L _{WA} 70 dB(A)

	Hz	kVA
400 V / 3 ~ 230 V	50 50	72,0 (104,0 A) 21,6 (93,8 A)

Pos. Item Rep. Voce Pos. Ref.	Anz. Qty. Qte Qta. Cant. Cant.			L (m)	B (m)	H (m)	kg	
1	3	Raupenunterwagen / Crawler undercarriage Châssis à chenilles / Carro cingolato Carro sobre railes / Carro de lagarta		5,835	2,55 [Ⓐ] 2,65 [Ⓑ]	1,46	12000	
2	1	Stromgenerator mit Konsole / Current generator with bracket / Générateur de courant avec semelle Generatore di corrente con supporto / Generator de corriente con consola / Gerador de corrente de consola		72 kVA	2,49	1,03	1,48	1350
3	1	Transportachse vorne Tra 100 KY 6A Road transport axle front / Essieux de transport avant / Asse di trasporto anteriore / Eje delantero para transporte / Eixo de transporte dianteiro			3,63 - 4,13	1,42	1,10	920
4	1	Transportachse hinten Tra 203 Road transport axle behind / Essieux de transport arrière / Asse di trasporto posteriore / Eje trasero para transporte / Eixo de transporte traseiro			2,50	2,50	1,00	2000

Konstruktionsänderungen vorbehalten!

Subject to alterations! / Sous réserves de modifications!
Si fa riserva di modifiche! / Salvo modificação da construação!
¡Sujeto a modificaciones!

Sämtliche Angaben erfolgen ohne Gewähr. / This information is supplied without liability.

Ces renseignements sont sans garantie. / Le indicazioni contenute si intendono salvo errori ed omissioni.
Declinamos toda responsabilidad derivada de la información proporcionada.
Declinamos qualquer responsabilidade quanto à informação fornecida.