

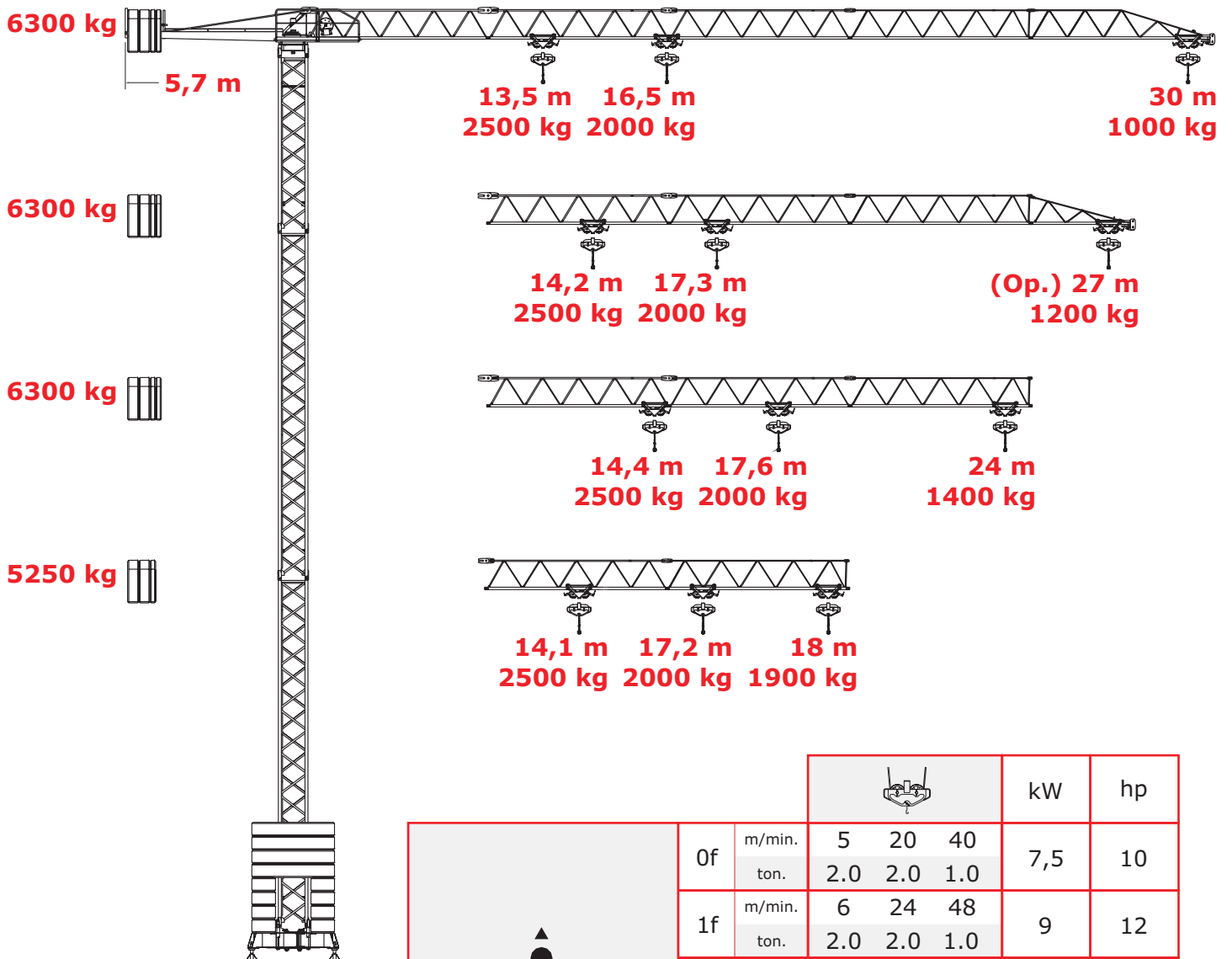



Grua Torre

Tower Crane

IT30f







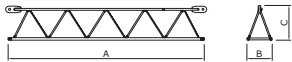
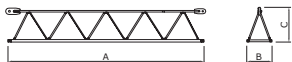
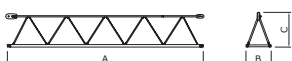
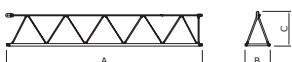
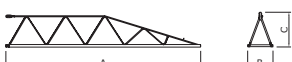

					kW	hp	
	0f	m/min.	5	20	40	7,5	10
		ton.	2.0	2.0	1.0		
	1f	m/min.	6	24	48	9	12
		ton.	2.0	2.0	1.0		
2f	m/min.	6	29	58	11	15	
	ton.	2.5	2.5	1.25			
		m/min.					
		ton.					
		m/min.	15	30	50	2,2	3
		rpm	1,2			3	4

CEI 38 	IEC 38	kVA	
400V (+6% -10%) 50Hz		0f - 16 kVA 2f - 20 kVA 1f - 18 kVA	2000 / 14 / CE

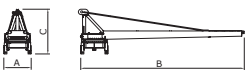
Flat-Top

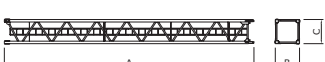
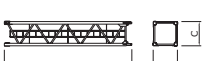
IT Gruas

IT30f	A (mm)	B (mm)	C (mm)	Peso (kg)
E2e 	6366	800	1075	429
E3 	6336	800	1054	328
E4 	6281	800	1032	228
E5 	6234	800	1015	199
E6b 	6169	800	1017	192
E6a 	3538	800	1017	109
	1040	6215	1699	915
	2060	380	1440	2100
	2060	190	1440	1050
	11854	1000	1000	1446
	6055	1000	1000	698
	3235	1000	1000	414



irmãos tavares 2

Fabrico de Gruas, Lda.

CONCEÇÃO, FABRICO E COMERCIALIZAÇÃO DE MÁQUINAS PARA A CONSTRUÇÃO CIVIL

Malaposta, 4520-506 - Sanfins (Santa Maria da Feira) Portugal

Tel.: 00 351 256 910 140 - Fax.: 00 351 256 910 149

geral@irmaostavares.com - www.irmaostavares.com

